

Instrukcja montażu

Domek ogrodowy z bali BORNEO

szerokość 500 x długość 595 cm

Grubość balika - 34 mm





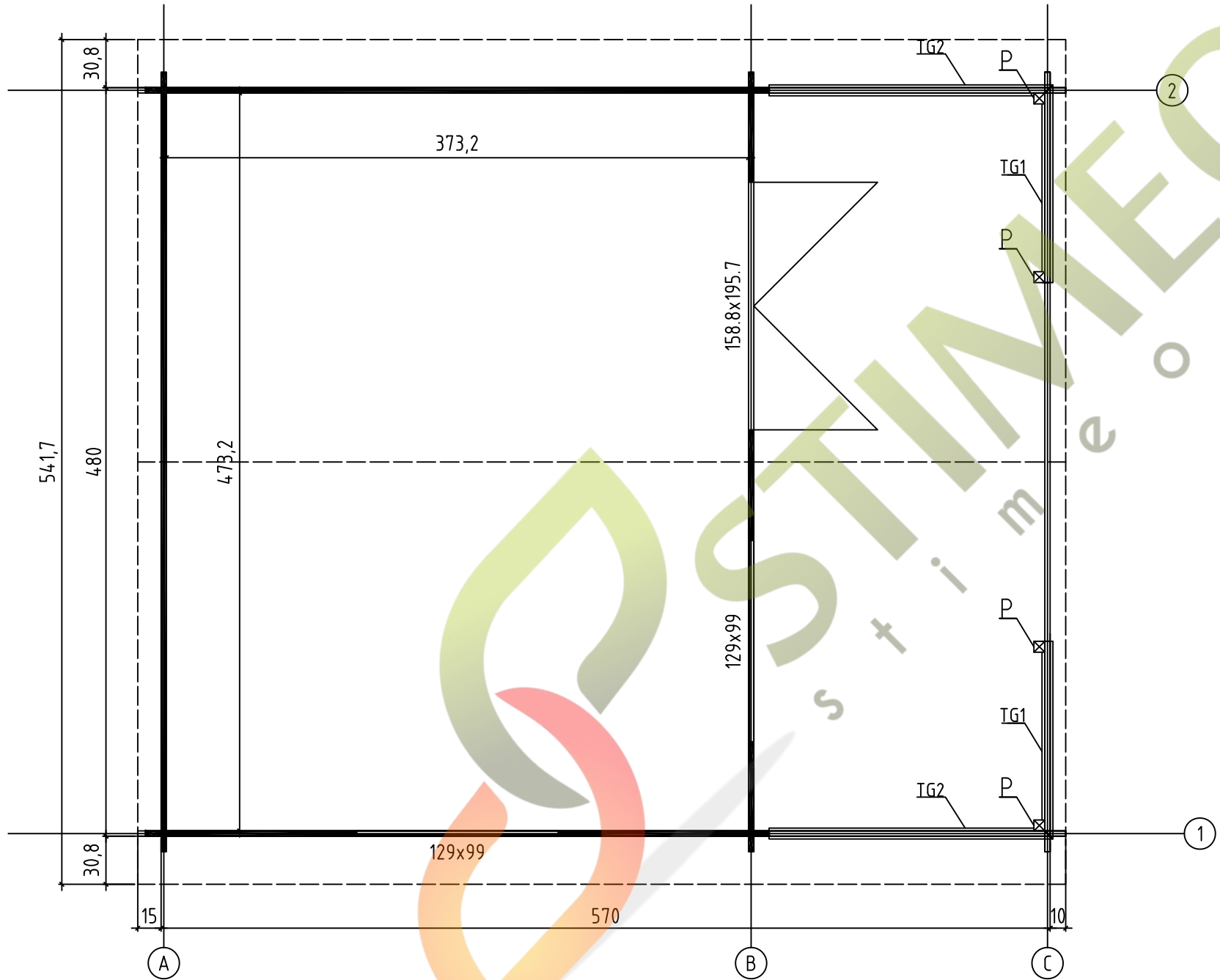

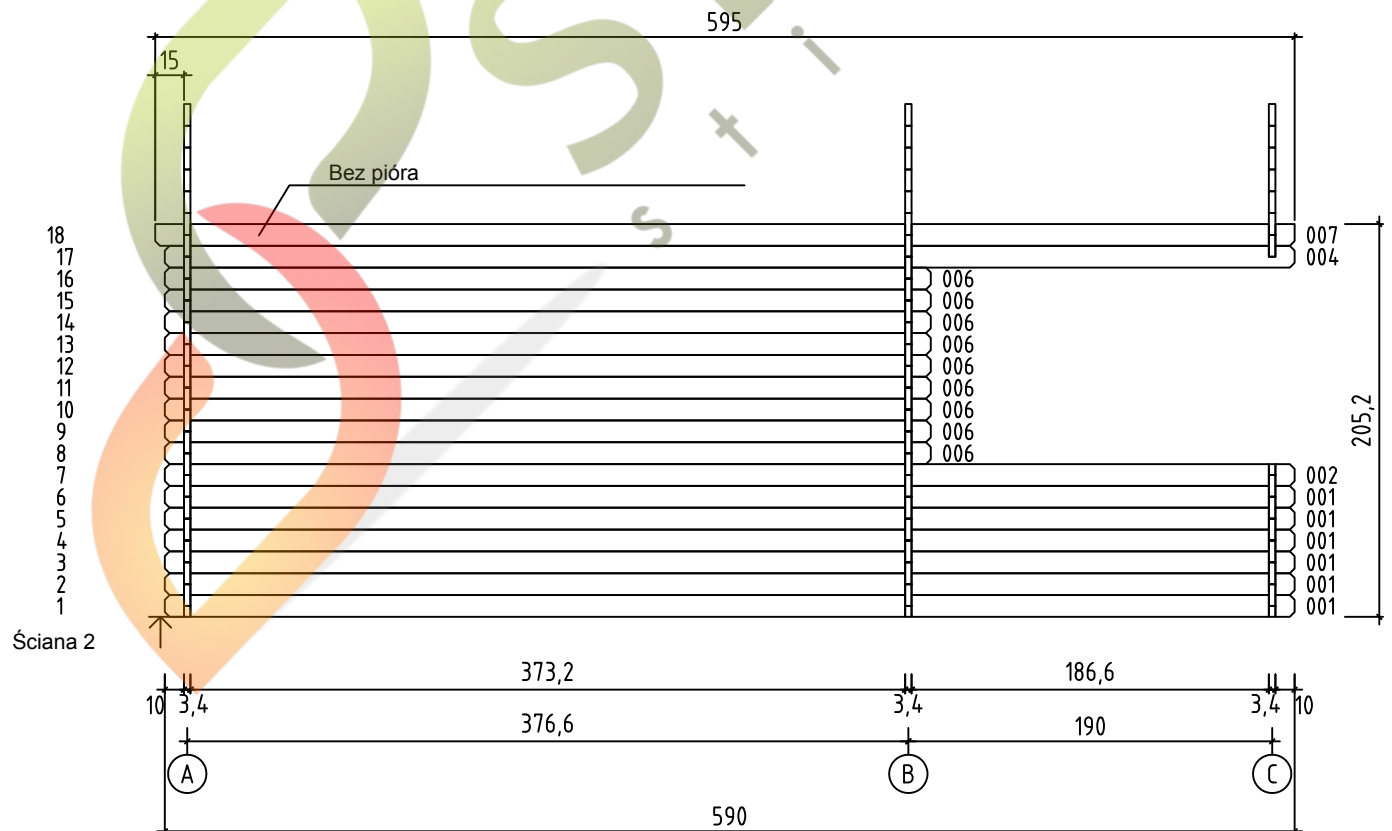
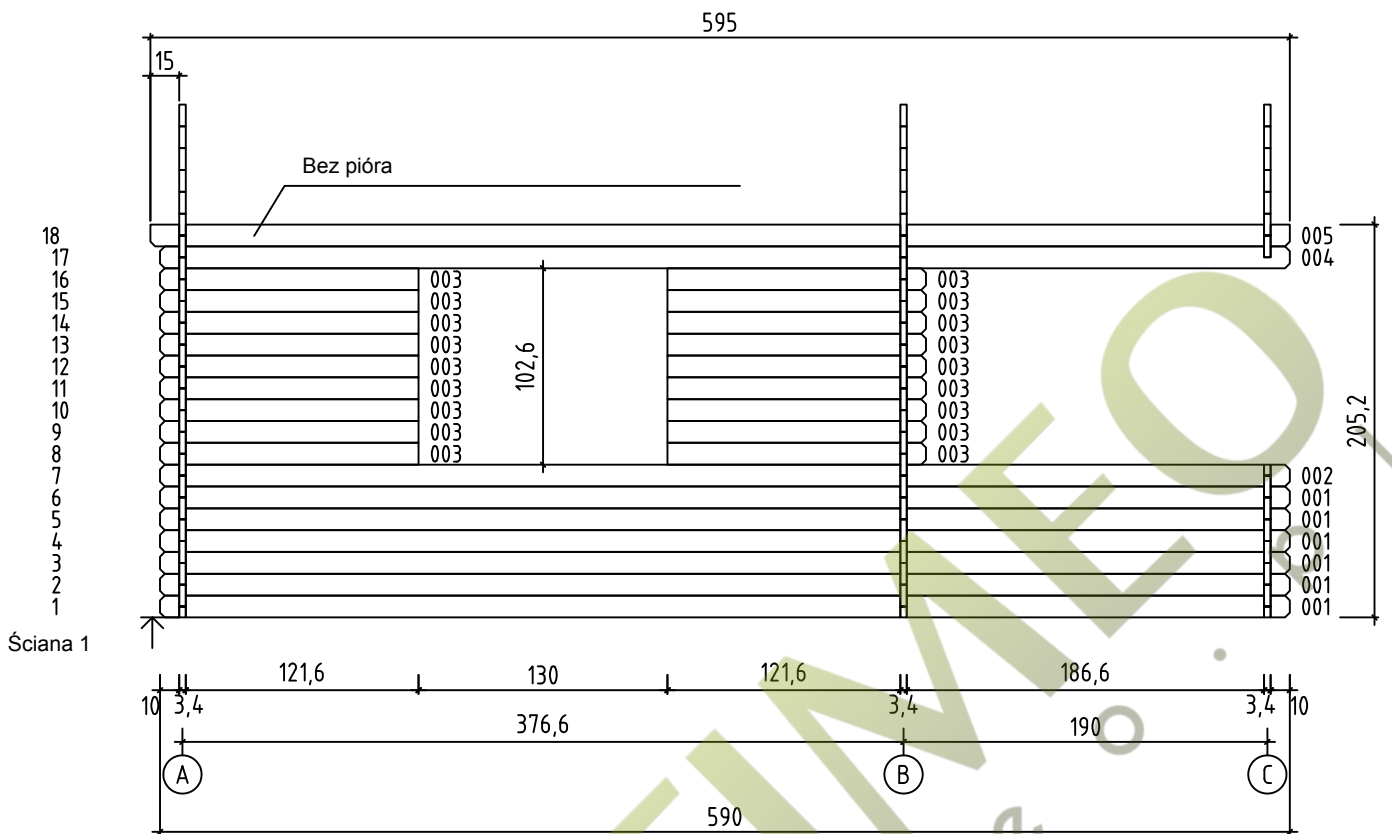

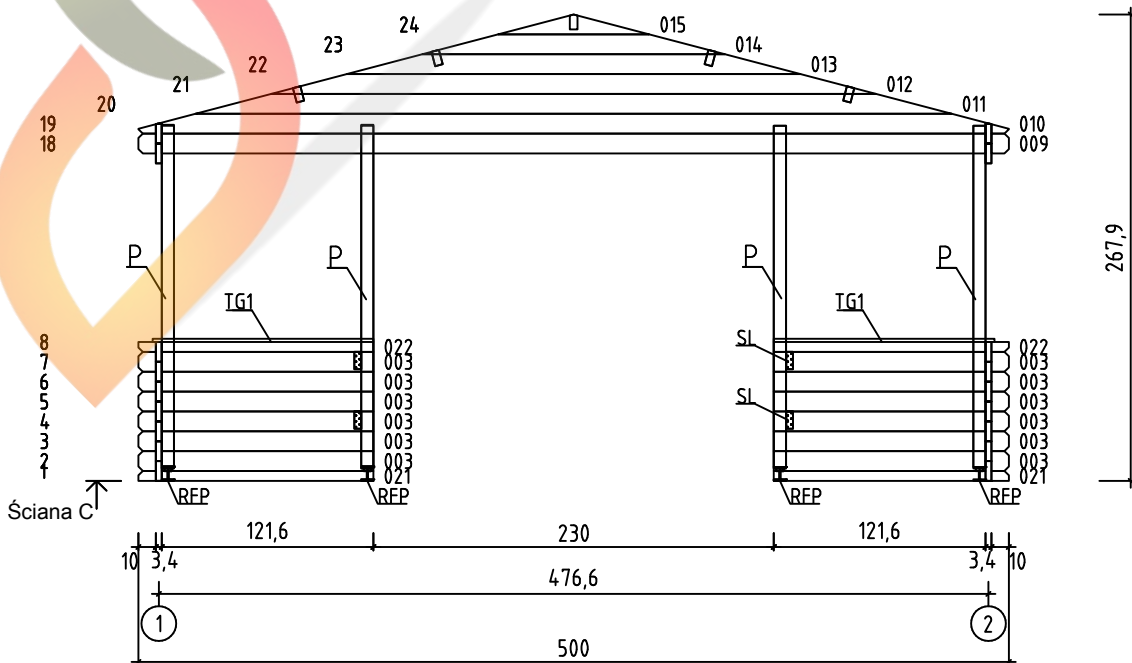
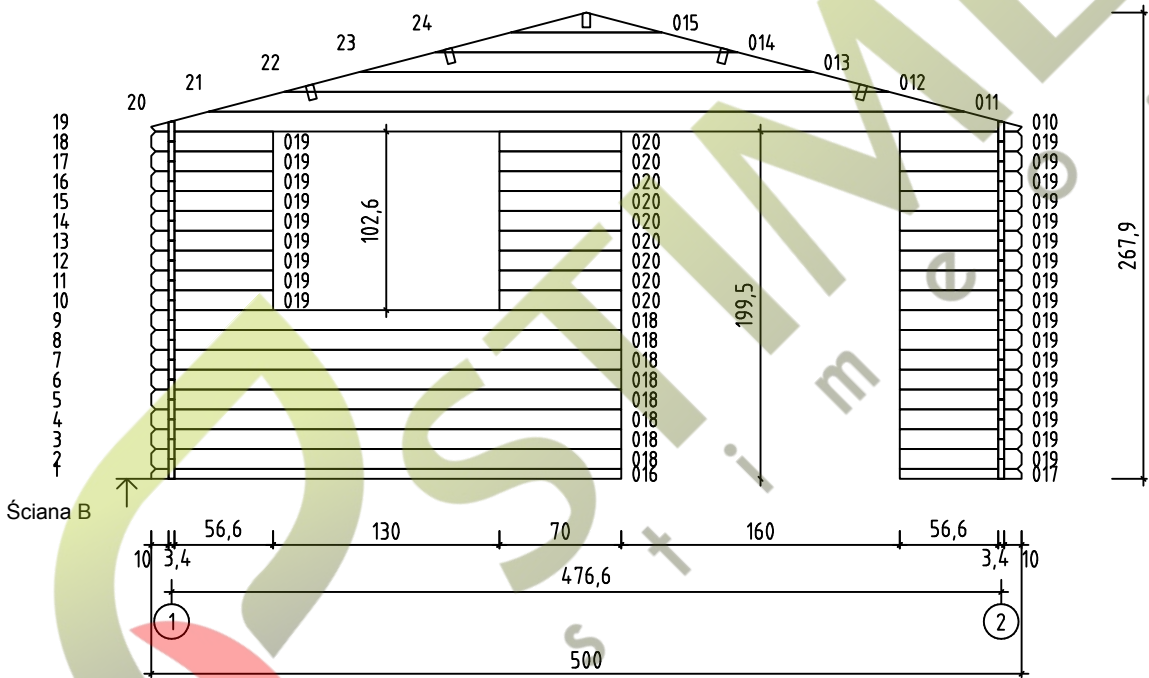
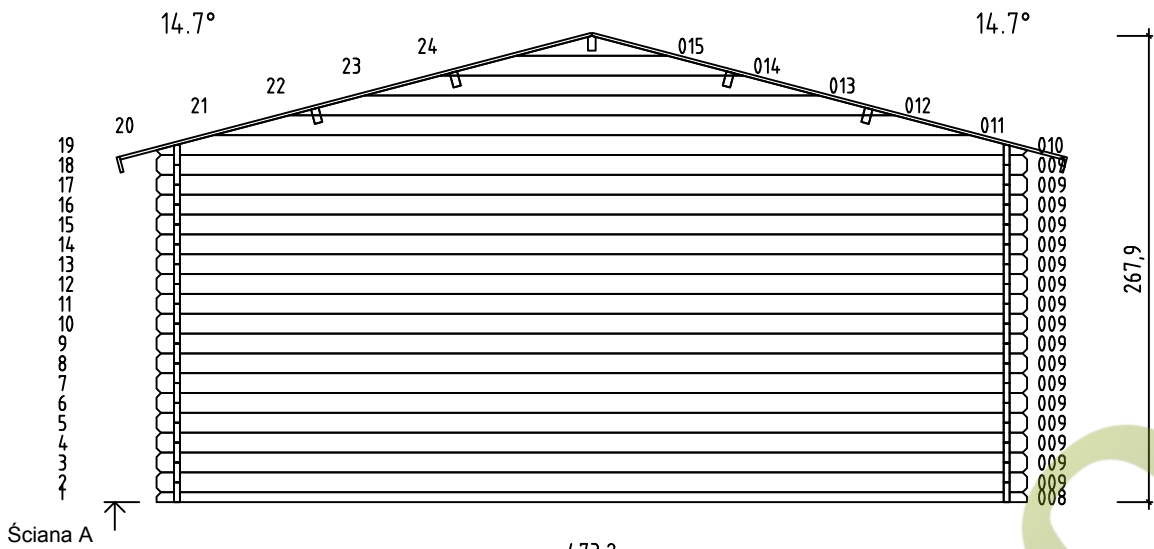

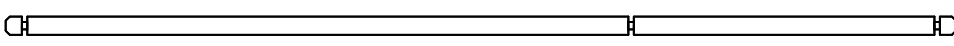
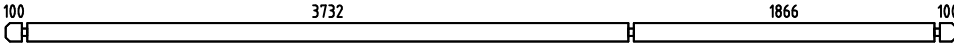
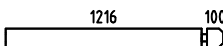
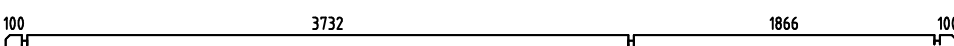

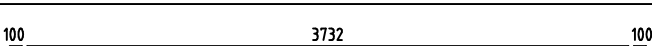
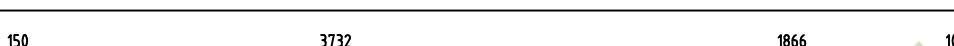
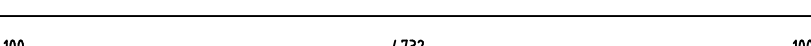
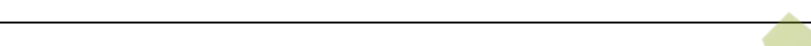
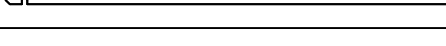

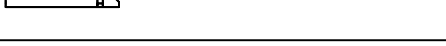
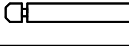
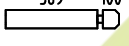

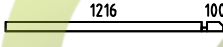
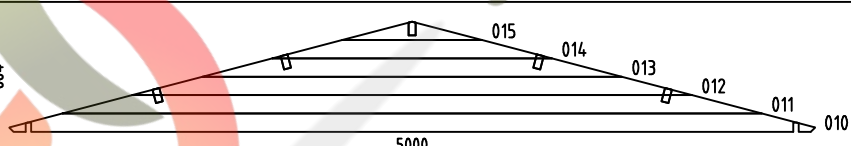
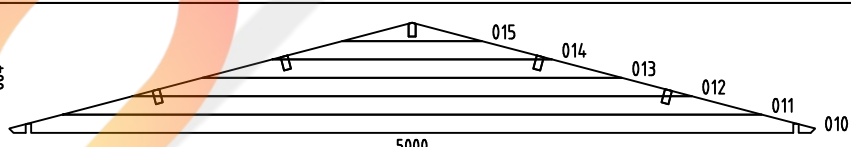
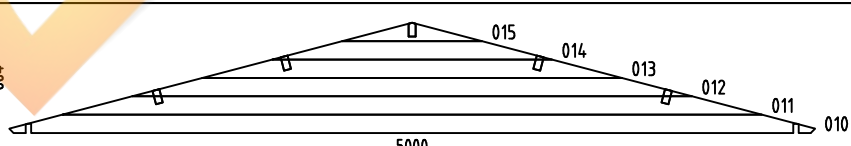
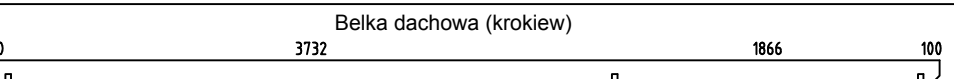
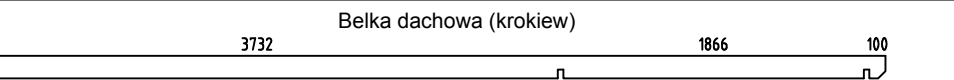





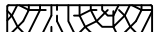

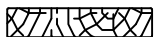
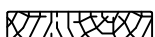
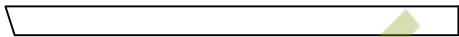

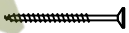

Plan podstawy domku

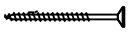
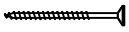
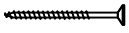

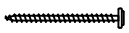
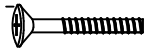

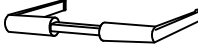

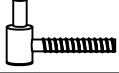
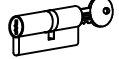

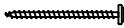

Poz.	Specyfikacja - lista elementów	Ilość sztuk	Wymiary profilu (mm)	Długość (mm)
001		12	34x114	5900
002		2	34x114	5900
003		30	34x114	1350
004		2	34x114	5900
005		1	34x120	5950
006		9	34x114	4000
007		1	34x120	5950
008		1	34x57	5000
009		18	34x114	5000
016		1	34x57	2700
017		1	34x57	700
018		8	34x114	2700
019		26	34x114	700
020		9	34x114	700
021		2	34x57	1350
022		2	34x57	1350
WA-1		1		
WB-1		1		
WC-1		1		
PR11	Belka dachowa (krokiew) 	1	44x140	5950
A.PR21	Belka dachowa (krokiew) 	4	44x140	5950
DB	Płyty dachowe 	134	90x18	2800

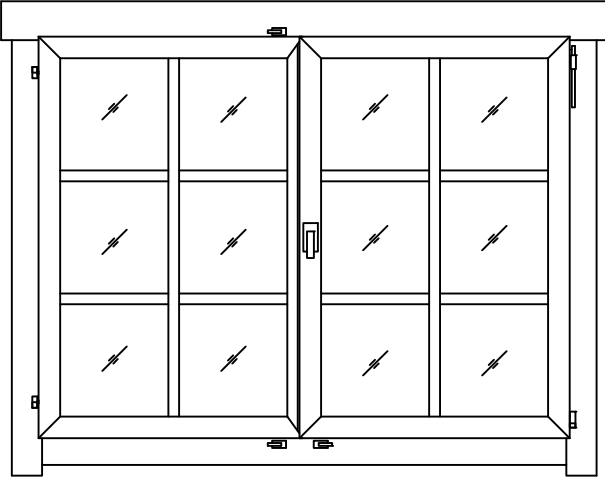
Poz.	Specyfikacja - lista elementów		Ilość sztuk	Wymiary profilu (mm)	Długość (mm)
DPL	Listwa dociskowa do papy dachowej		4	18x58	2850
P	Słupek		4	70x70	1960
TB	Deska okapowa		4	18x90	2975
DRV	Deska wzmacniająca krawędź dachu		4	28x34	2975
TG1	Oslona (poręcz na taras)		2	18x70	1268
TG1	Oslona (poręcz na taras)		2	18x70	1820
GL	Listwa szczytowa		4	18x120	2850
FS	Klamka okiena z szyldem (z okuciem do mocowania)		2		
HS88	Wkręt do okiennic		18	2.5x20	
HS89	Wkręt do drzwi (zasłony)		16	2.5x20	
HS3	Wkręt do listwy drzwiowej		5	3x30	
HS37	Wkręt do słupka		8	4.5x80	
HS104	Wkręt do łącznika ściany przesuwnej		12	4x25	
HS41	Wkręt do ościeżnicy (futryny) drzwi		4	5x90	
HS49	Wkręt do słupka regulującego wysokość		32	6x50	
SH34	Dobijak mocujący		1		
MS	Wkręt do progu		3	4.5x65	
TS	Śruba mocująca szyld (okucie) klamki okiennej		4		
GS	Element szczytowy (łączy na szczycie z boku)		2		
SL	Łącznik ścienny (przesuwny)		4		
TS3	Klamka (do obu stron drzwi)		1		
TS4	Szyld (okucie do mocowania) klamki i zamka		1		
TS2	Zawias do drzwi		6		
TS6	Zamek cylindryczny		1		
RFP	Słupek regulujący wysokość		4		

Poz.	Specyfikacja - lista elementów	Ilość sztuk	Wymiary profilu (mm)	Długość (mm)
	Wkręt do łącznika ściany przesuwnej 	4	5x40	
	Podkładka do łącznika ściany przesuwnej 	4		
	<p data-bbox="603 320 767 344">Okno 1290 x 990</p>  <p data-bbox="1137 300 1182 324">SGC</p>	2		
	<p data-bbox="579 1095 759 1120">Drzwi 1588 x 1957</p> 	1		