

















# Spis części

PART	NO.	Qty.
	2	2
	5	4
	8	4
	9	2
	11	2
	12	1
	27	4
	P1	4
	P2	4
	S1	20
	S4	4
	S5	2
	F1	20
	F2	16
	F3	28
	F4	12



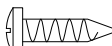
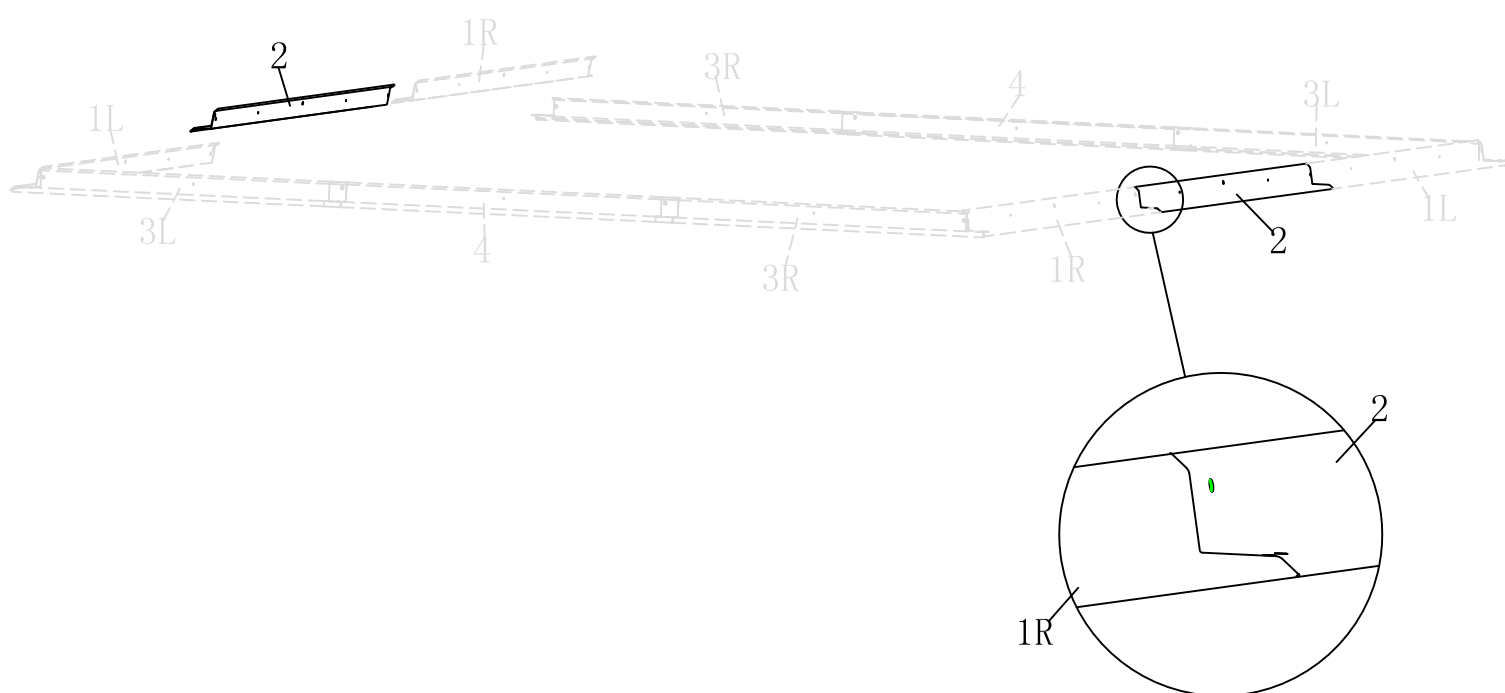

# Krok 1

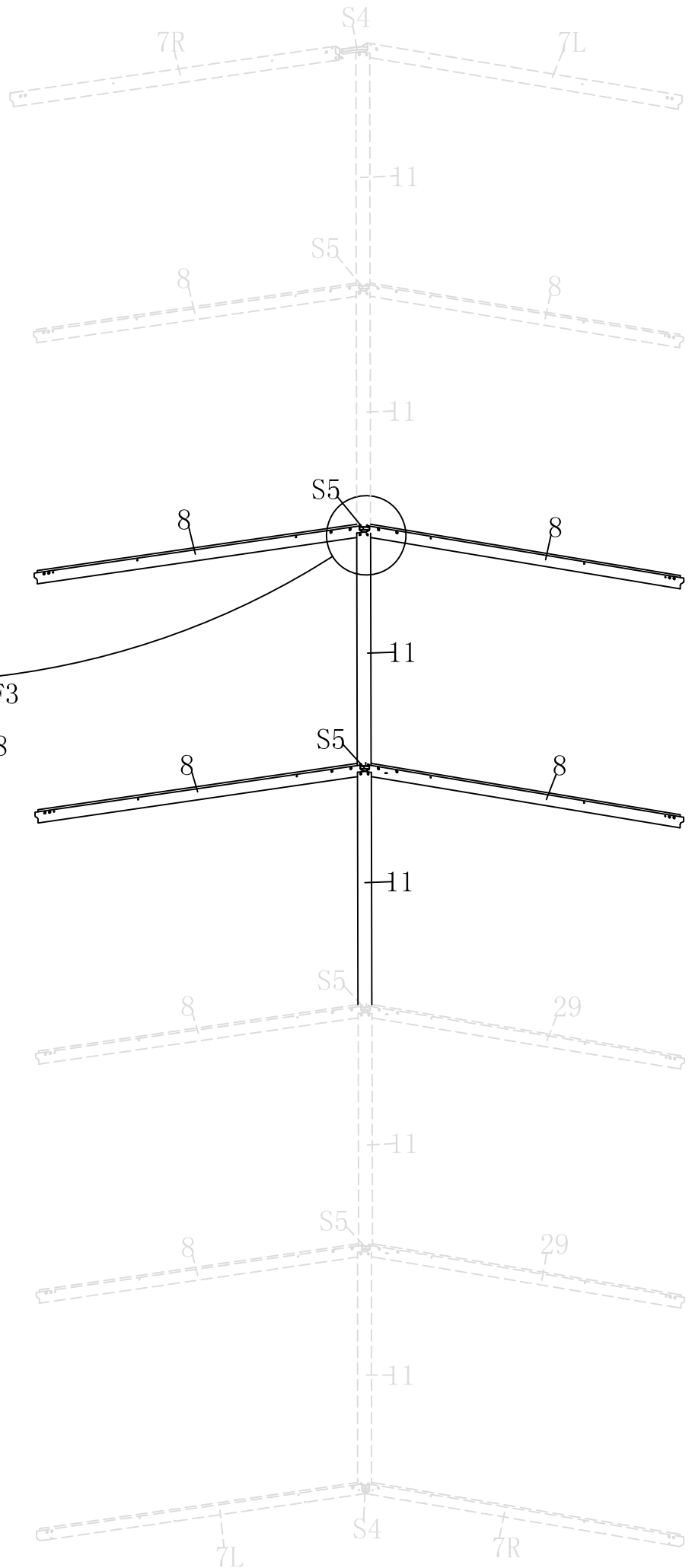

PART	NO.	Qty.
	2	2
	F2	8

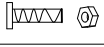

# Krok 2



PART	NO.	Qty.
	8	4
	11	2
	S5	2
	F2	8
	F3	4

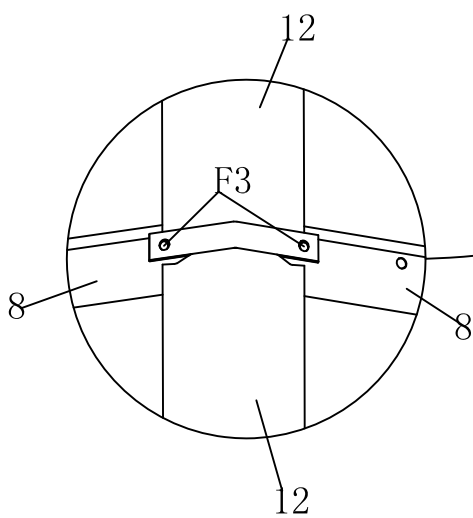
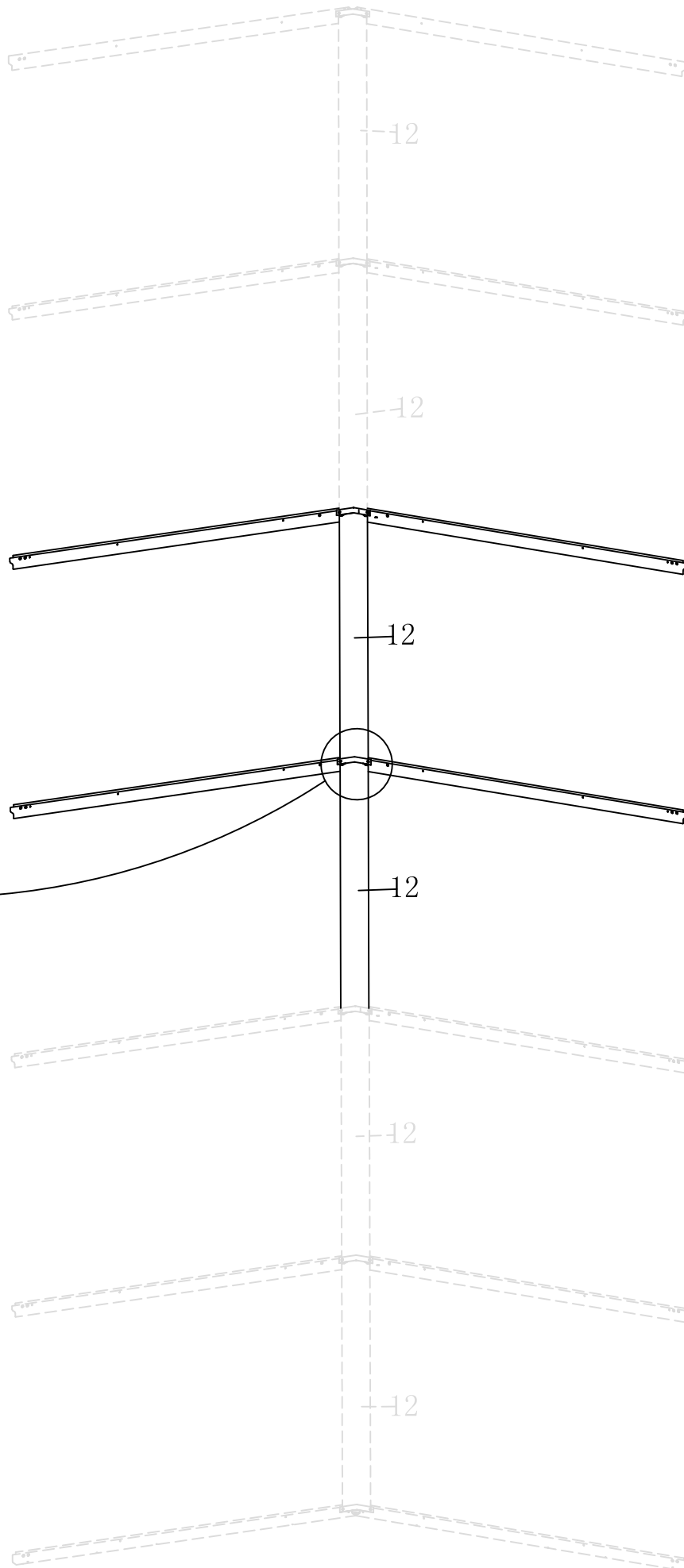



# Krok 3

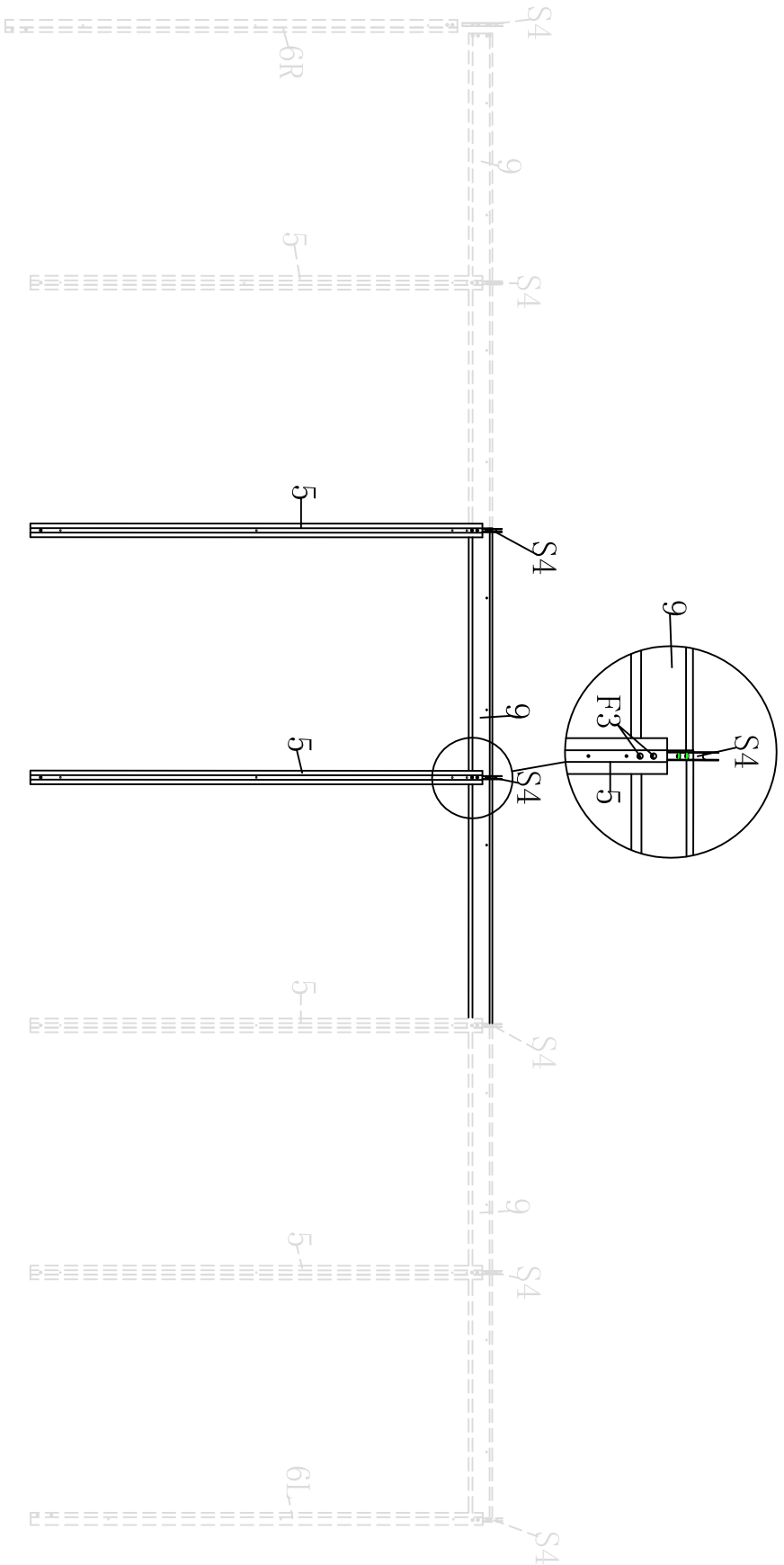

PART	NO.	Qty.
	12	1
	F3	4

# Krok 4



PART	NO.	Qty.
	5	4
	9	2
	S4	4
	F3	8

# Krok 5

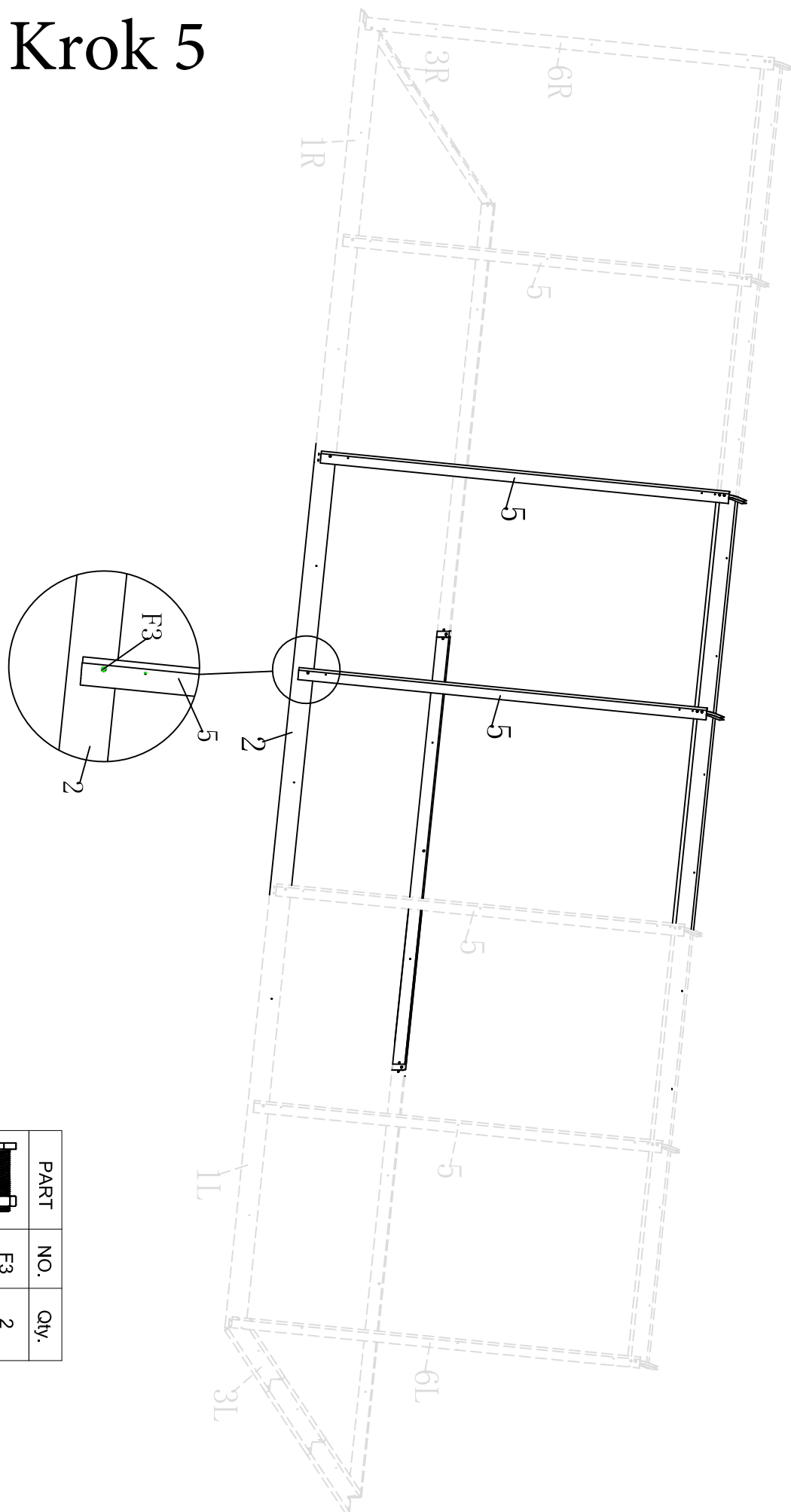

PART	NO.	Qty.
	F3	2

# Krok 6

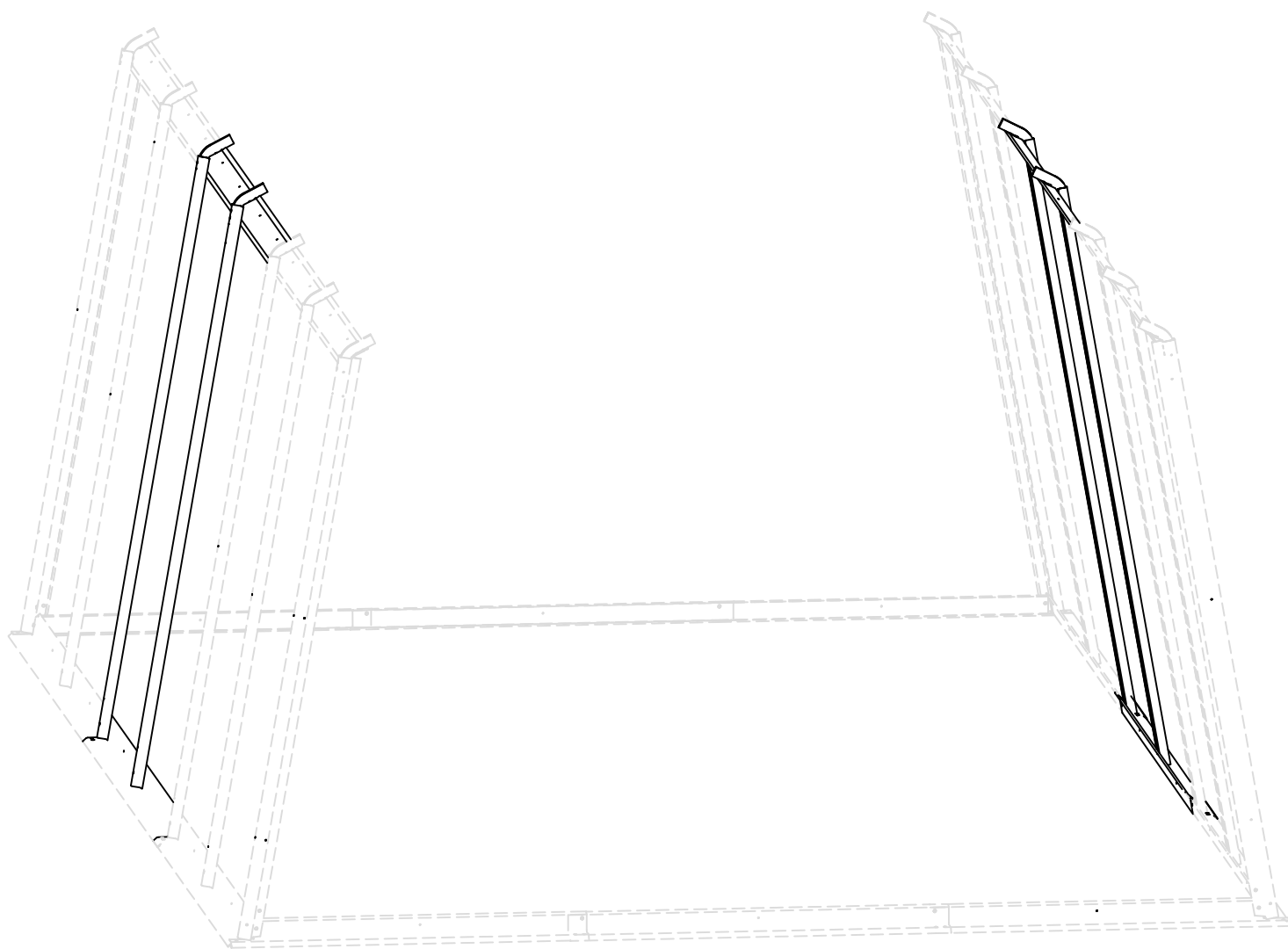

PART	NO.	Qty.
	F3	2





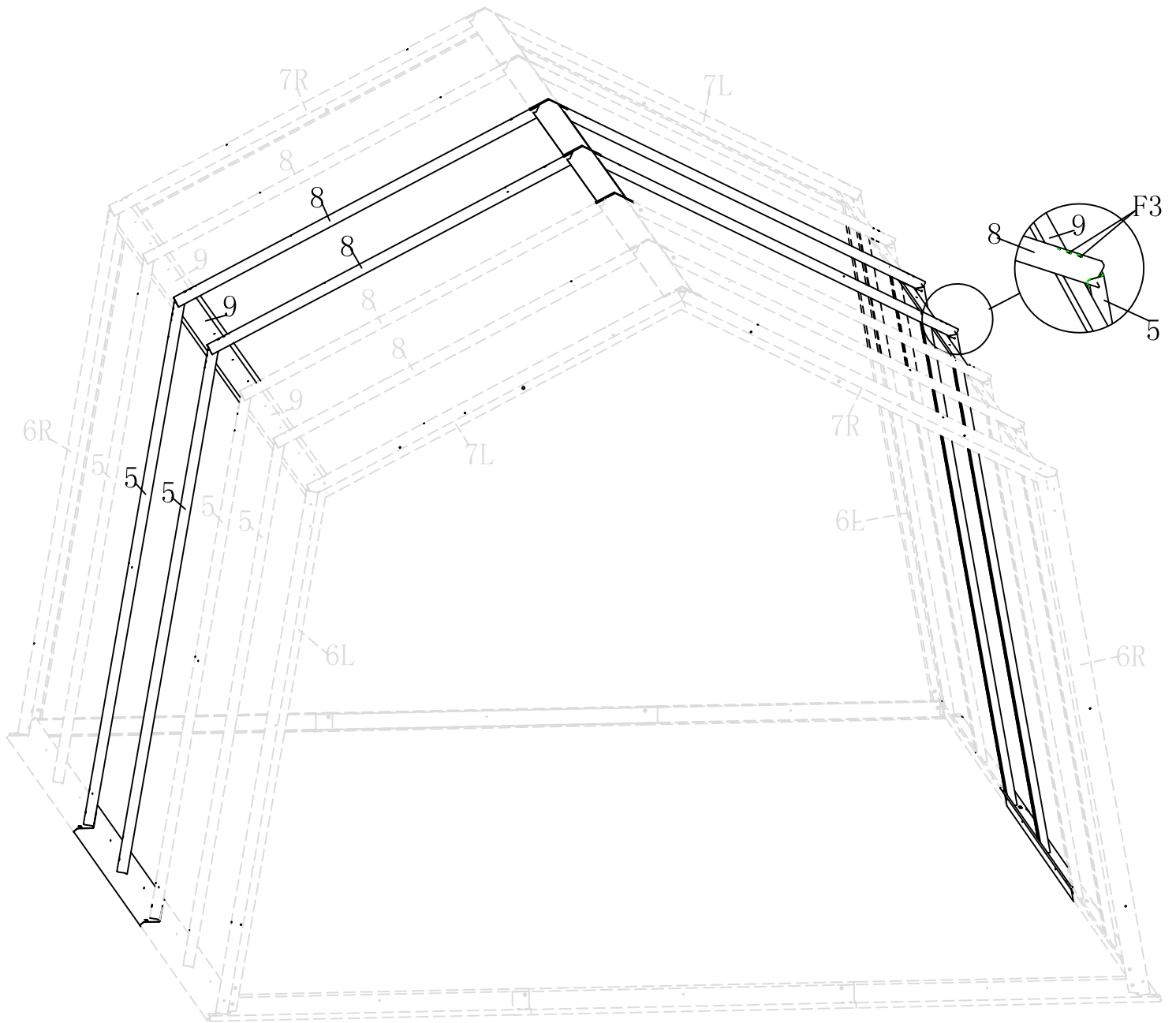



# Krok 7

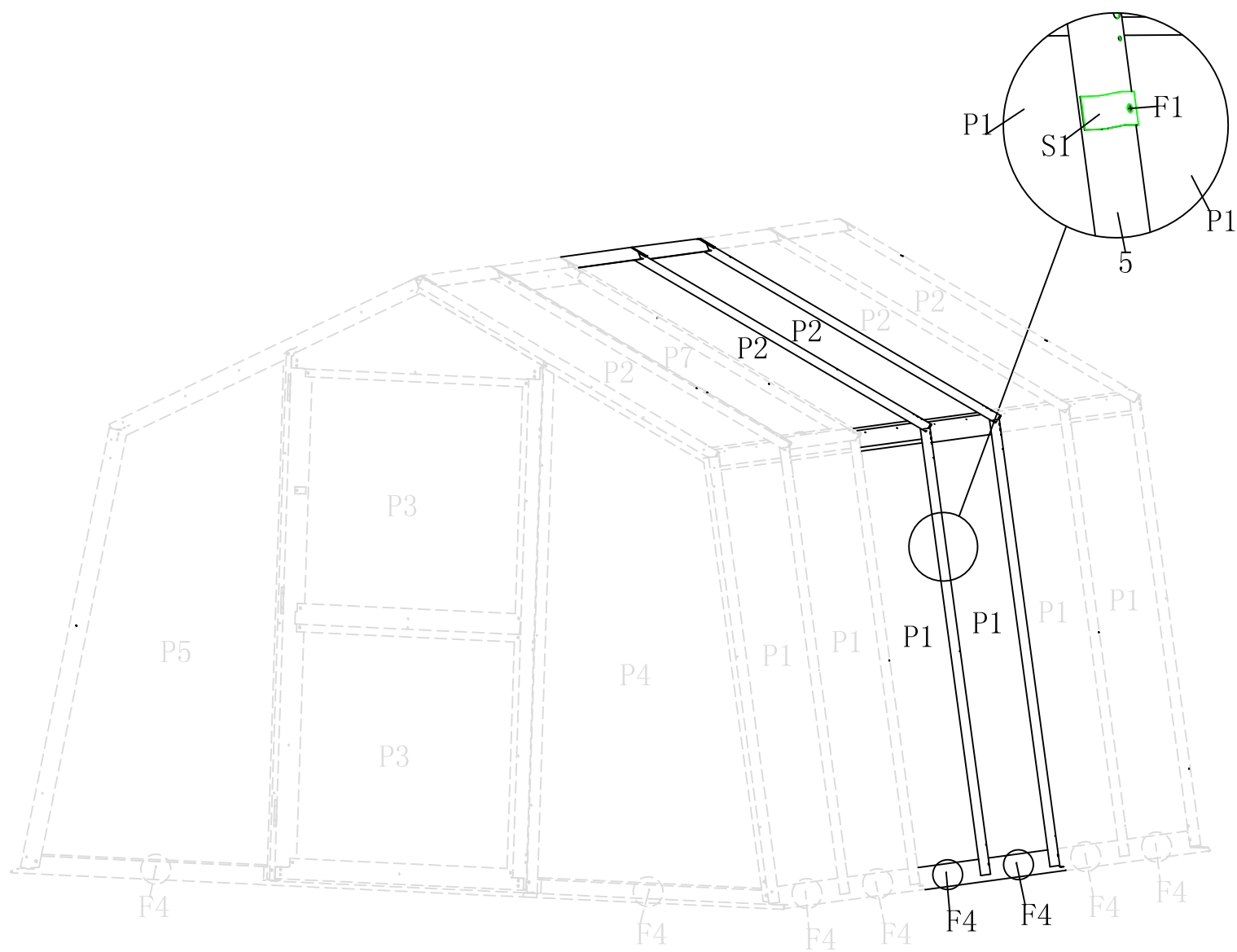

PART	NO.	Qty.
	F3	8





# Krok 8

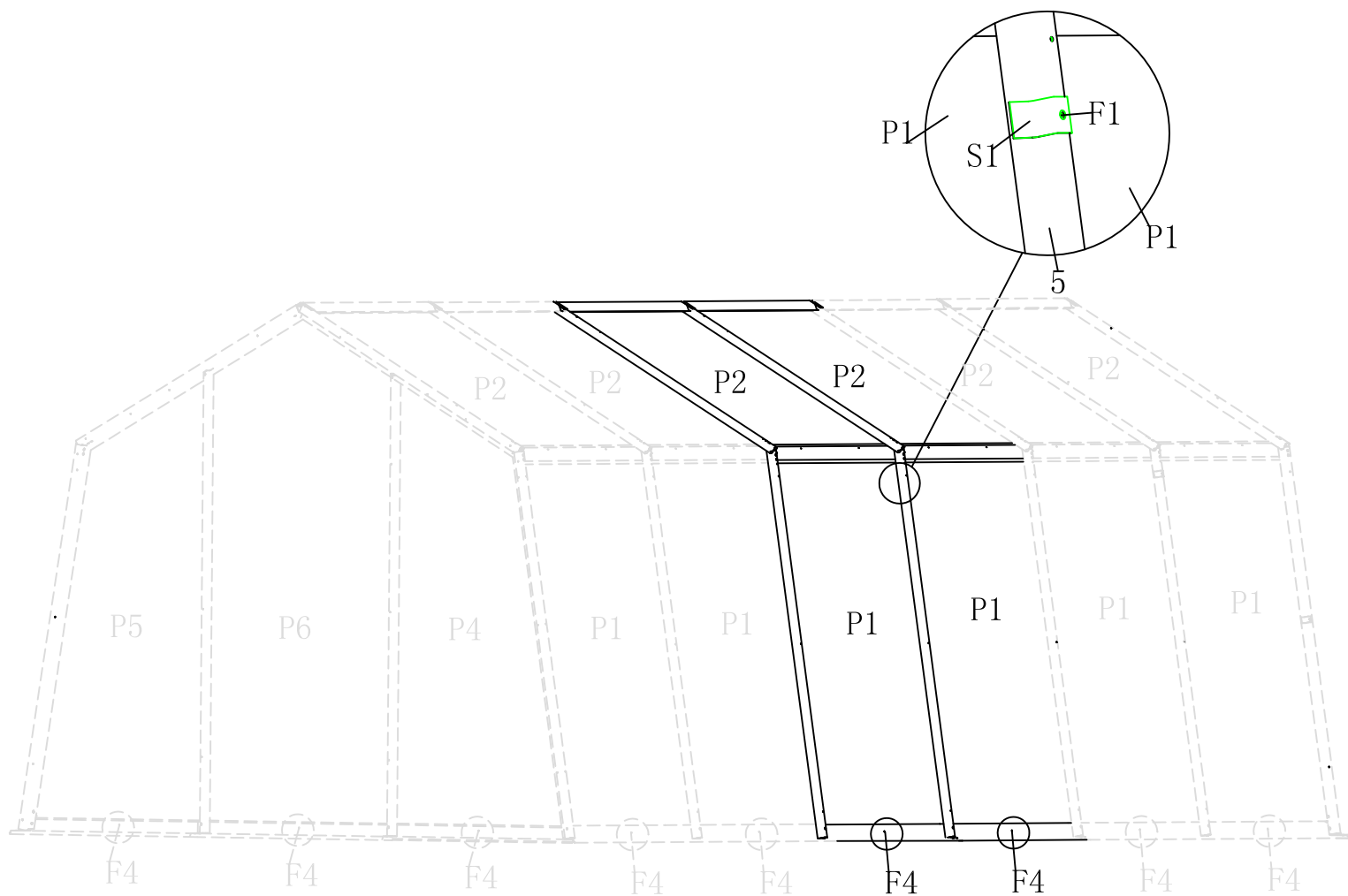

PART	NO.	Qty.
	P1	2
	P2	2
	S1	10
	F1	10
	F4	2



# Krok 9

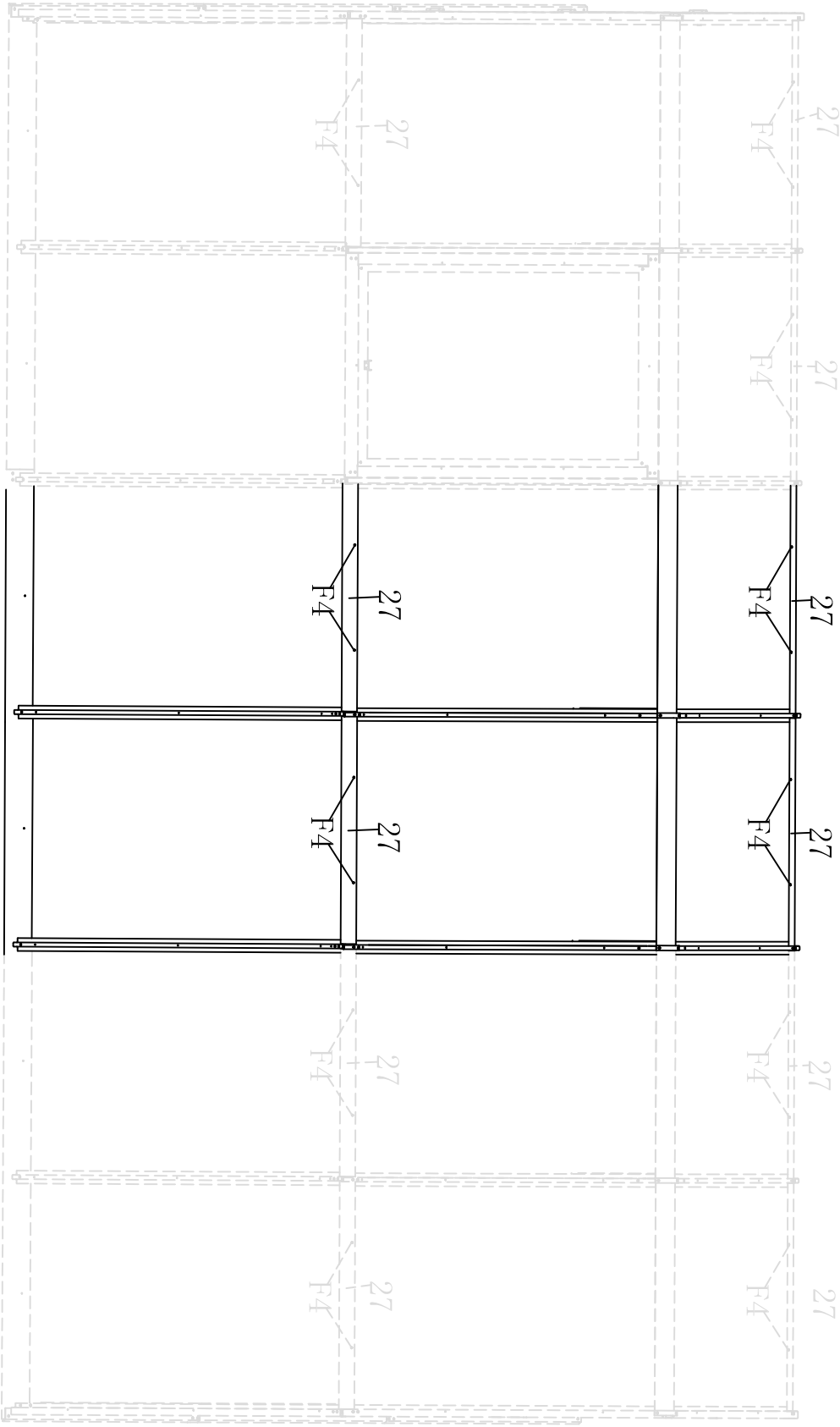

PART	NO.	Qty.
	P1	2
	P2	2
	S1	10
	F1	10
	F4	2

# Krok 10



PART	NO.	QTY.
	27	4
	F4	8

# Krok 11

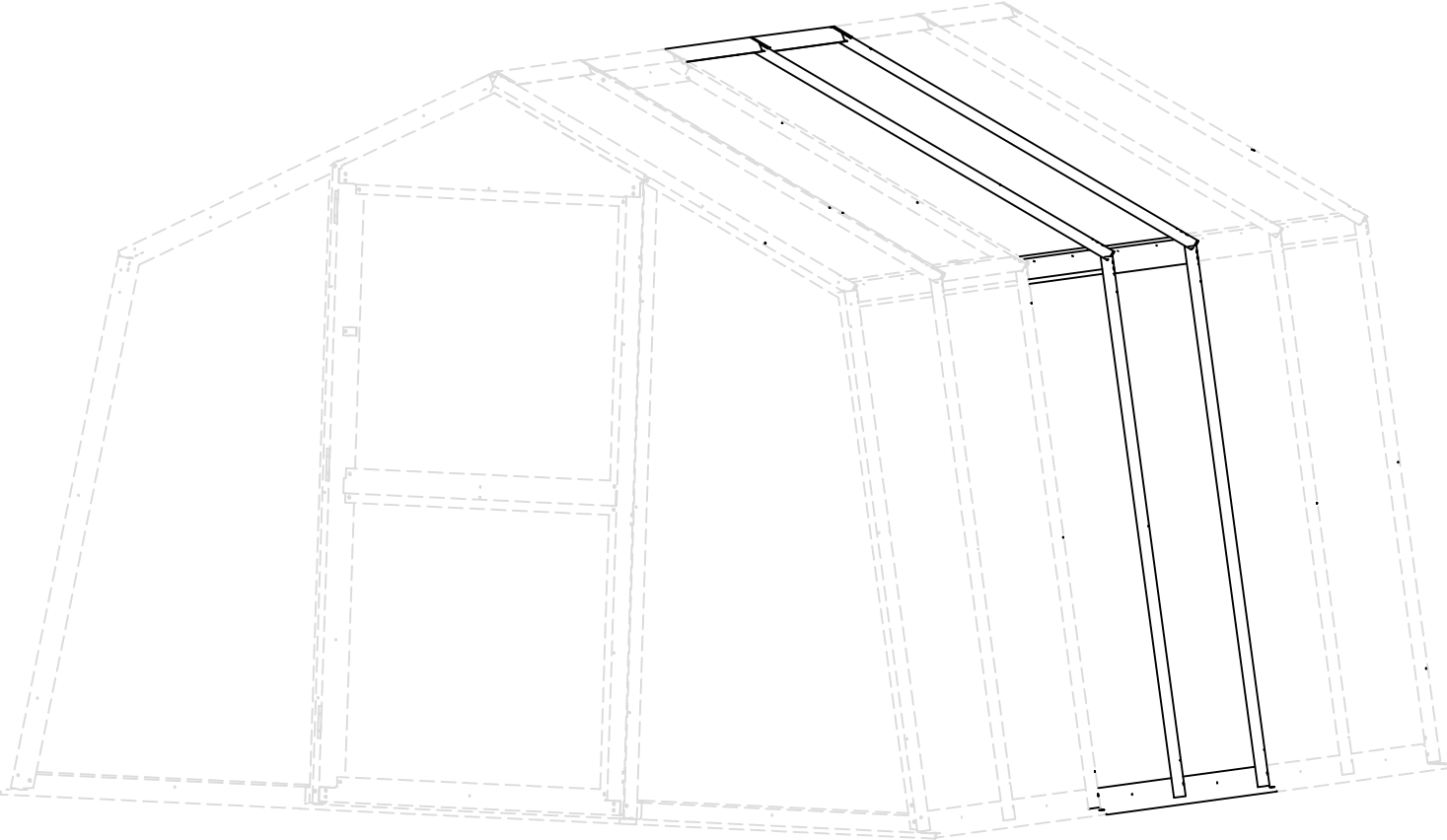

# Krok 12

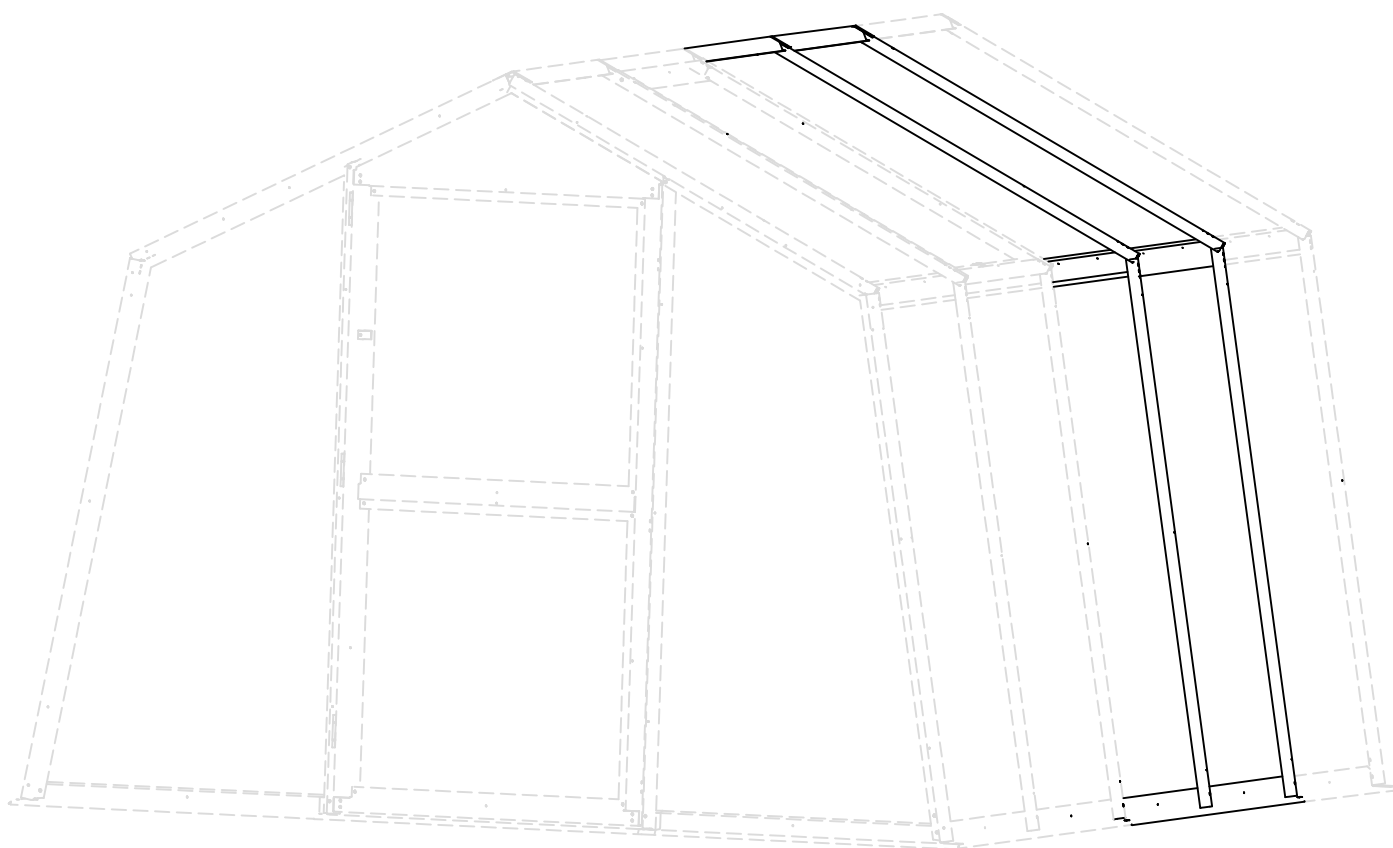

# Krok 13

